



# JAY FLIGHT | 2017



SLX



JAY FLIGHT



BUNGALOW





# #LETSJAYCO

Where do you want to go? With Jayco, you're headed straight for family fun—regardless of the destination. From wooded campgrounds to sandy beaches, swimming hole docks to scenic byways, maximize the moment with unmatched quality and added comfort. So what are you waiting for? Make new memories—and share them with the world.

## GENERATIONS OF FAMILY FUN



### **Jay Flight SLX: Page 4**

The 2017 Jay Flight SLX lineup features numerous easy-to-tow models



### **Jay Flight: Page 6**

The 2017 Jay Flight lineup boasts family-friendly floorplans ranging from 23 to 38 feet in length



### **Jay Flight Bungalow: Page 14**

Each spacious 2017 Jay Flight Bungalow model includes several standard residential features

# JAY FLIGHT

## 1968 TO TODAY: GENERATIONS OF FAMILY FUN

If it's not done well, it's not worth doing. That was Jayco founder Lloyd Bontrager's philosophy. He thought that his family deserved a better RV—and that yours does, too. One that's sturdy, carefully designed and built to last. Nearly 50 years later, his legacy lives on—in the Jay Flight.

**Discover America's No. 1-selling travel trailer.**



## JAY FLIGHT THROWBACK

Here's our 2005 Jay Flight brochure cover—the year we first became America's best-selling travel trailer.



287BHSW | SMOKE



# JAY FLIGHT SLX



174BH | SMOKE



287BHSW KITCHEN



287BHSW ENTERTAINMENT CENTER (CUSTOMER-SUPPLIED TV)



PASS-THROUGH STORAGE (MOST MODELS)



FOOT FLUSH TOILET



SIMMONS® MATTRESS (SELECT MODELS)



INTERIOR LED LIGHTING

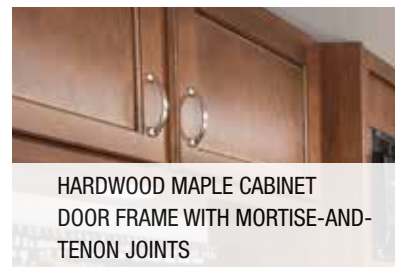

HARDWOOD MAPLE CABINET DOOR FRAME WITH MORTISE-AND-TENON JOINTS



POWER AWNING AND EXTERIOR SPEAKERS



174BH



34RSBS | CANYON

### POPULAR OPTIONS



FIBERGLASS SIDEWALLS WITH FRAMELESS WINDOWS



THERMAL PACKAGE: INSULATED, HEATED (N/A ON 23RB, 26BH) AND ENCLOSED UNDERBELLY AND 2-SIDED REFLECTIVE FOIL IN MAIN ROOF AND SLIDEOUT FLOORS



MULTI-FUNCTION DIGITAL REMOTE

### STANDARD FEATURES



POWER AWNING WITH LED LIGHT



DINETTE STORAGE WITH REMOVABLE TRAYS

## MAIN INTERIOR KEY

1. Interior LED lighting
2. Decorative lighting above dinette and on slideout wall
3. 8-cubic-foot refrigerator
4. Shaw® residential carpet
5. DiamondFlor® vinyl flooring
6. Directional and closeable A/C ducts
7. Maple mission-style cabinet doors



# JAY FLIGHT

## ELITE PACKAGE

- Black tank flush
- Second fresh water tank (80-gallon capacity)
- Large entry grab handle\*
- Upgrade faucet with pullout sprayer and sink covers\*
- Porcelain foot flush toilet
- Stainless kitchen appliances\*
- Maple mission-style cabinet doors
- AM/FM/CD/DVD player with MP3 hookup and Bluetooth®/HDMI®\*
- Solar prep
- Dual USB/12V charging\*
- Simmons® mattress\*

\*Pictured below



LARGE ENTRY GRAB HANDLE



UPGRADE FAUCET WITH PULLOUT SPRAYER AND SINK COVERS



STAINLESS KITCHEN APPLIANCES



AM/FM/CD/DVD PLAYER WITH MP3 HOOKUP AND BLUETOOTH/HDMI



POWER TONGUE JACK



75-POUND CAPACITY BALL-BEARING DRAWER GUIDES



DUAL USB/12V CHARGING



SIMMONS MATTRESS

## JAY FLIGHT SLX FLOORPLANS

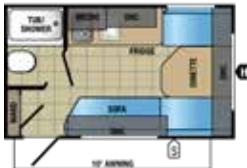

**JAY FLIGHT SLX | 145RB**  
Ext. Lgth: 16' 6" Ext. Ht: 111"  
Unloaded Wt (lbs.): 2,330 Sleeps: 2-3



**JAY FLIGHT SLX | 154BH**  
Ext. Lgth: 17' 10" Ext. Ht: 109"  
Unloaded Wt (lbs.): 2,520 Sleeps: 3-4



**JAY FLIGHT SLX | 174BH**  
Ext. Lgth: 21' 6" Ext. Ht: 113"  
Unloaded Wt (lbs.): 2,880 Sleeps: 5



**JAY FLIGHT SLX | 175RD**  
Ext. Lgth: 20' 7" Ext. Ht: 113"  
Unloaded Wt (lbs.): 2,855 Sleeps: 3-4



**JAY FLIGHT SLX | 195RB**  
Ext. Lgth: 21' 8" Ext. Ht: 113"  
Unloaded Wt (lbs.): 2,905 Sleeps: 3-4



**JAY FLIGHT SLX | 212QBW**  
Ext. Lgth: 25' 6" Ext. Ht: 127"  
Unloaded Wt (lbs.): 4,185 Sleeps: 4



**JAY FLIGHT SLX | 242BHSW**  
Ext. Lgth: 29' 2" Ext. Ht: 127"  
Unloaded Wt (lbs.): 5,390 Sleeps: 7-8



**JAY FLIGHT SLX | 245RLSW**  
Ext. Lgth: 28' 2" Ext. Ht: 132"  
Unloaded Wt (lbs.): 5,220 Sleeps: 4-6



**JAY FLIGHT SLX | 264BHW**  
Ext. Lgth: 29' 3" Ext. Ht: 126"  
Unloaded Wt (lbs.): 4,615 Sleeps: 8-10



**JAY FLIGHT SLX | 265RLSW**  
Ext. Lgth: 30' 11" Ext. Ht: 133"  
Unloaded Wt (lbs.): 5,925 Sleeps: 4-6



**JAY FLIGHT SLX | 267BHSW**  
Ext. Lgth: 30' 2" Ext. Ht: 133"  
Unloaded Wt (lbs.): 5,425 Sleeps: 8-10



**JAY FLIGHT SLX | 284BHSW**  
Ext. Lgth: 33' 5" Ext. Ht: 132"  
Unloaded Wt (lbs.): 6,035 Sleeps: 6-8



**JAY FLIGHT SLX | 287BHSW**  
Ext. Lgth: 33' 5" Ext. Ht: 132"  
Unloaded Wt (lbs.): 6,005 Sleeps: 8-10



**JAY FLIGHT SLX | 32BDSW**  
Ext. Lgth: 36' 2" Ext. Ht: 136"  
Unloaded Wt (lbs.): 7,195 Sleeps: 6-10

## JAY FLIGHT SLX SPECS

MODELS		DIMENSIONS			WEIGHT (LBS.)				TANKS (GALS.)		
FLOORPLAN	EXTERIOR TRAVEL LENGTH	EXTERIOR WIDTH	EXTERIOR HEIGHT (WITH A/C)	INTERIOR HEIGHT	UNLOADED VEHICLE WEIGHT	DRY HITCH WEIGHT	GROSS VEHICLE WEIGHT RATING	CARGO CARRYING CAPACITY	FRESH WATER CAPACITY (INCLUDES WATER HEATER)	GREY WASTE WATER CAPACITY	BLACK WASTE WATER CAPACITY
145RB	16' 6"	85"	111"	73"	2,330	225	2,995	665	16	15	9
154BH	17' 10"	85"	109"	73"	2,520	315	3,200	680	16	15	9
174BH	21' 6"	85"	113"	73"	2,880	320	3,500*	620	26	15	9
175RD	20' 7"	85"	113"	73"	2,855	305	3,500*	645	26	15	9
195RB	21' 8"	85"	113"	73"	2,905	235	3,500*	595	26	15	9
212QBW	25' 6"	96"	127"	81"	4,185	460	6,000	1,815	48	39	39
242BHSW	29' 2"	96"	127"	81"	5,390	605	7,000	1,610	44	39	39
245RLSW	28' 2"	96"	132"	81"	5,220	545	7,000	1,780	44	39	39
264BHW	29' 3"	96"	126"	81"	4,615	485	6,500	1,885	48	39	39
265RLSW	30' 11"	96"	133"	81"	5,925	676	7,500	1,575	44	39	39
267BHSW	30' 2"	96"	133"	81"	5,425	635	7,000	1,575	44	39	39
284BHSW	33' 5"	96"	132"	81"	6,035	710	7,500	1,465	44	39	39
287BHSW	33' 5"	96"	132"	81"	6,005	645	7,500	1,495	44	39	39
32BDSW	36' 2"	96"	136"	81"	7,195	825	8,750	1,555	46	32.5	39

\*GWR of Idaho-built units is 3,750 pounds





**JAY FLIGHT | 210B**

Ext. Lgth: 25' 6" Ext. Ht: 127" Unloaded Wt (lbs.): 4,385 Sleeps: 4



**JAY FLIGHT | 23RB OPTION A**

Ext. Lgth: 27' 2" Ext. Ht: 127" Unloaded Wt (lbs.): 4,560 Sleeps: 4-6



**JAY FLIGHT | 24RBS OPTION B**

Ext. Lgth: 28' 8" Ext. Ht: 127" Unloaded Wt (lbs.): 5,420 Sleeps: 4-6



**JAY FLIGHT | 26BH OPTIONS: A, C**

Ext. Lgth: 29' 3" Ext. Ht: 127" Unloaded Wt (lbs.): 4,805 Sleeps: 8-10



**JAY FLIGHT | 27BHS OPTIONS: B, D**

Ext. Lgth: 31' 8" Ext. Ht: 130" Unloaded Wt (lbs.): 6,335 Sleeps: 7-10



**JAY FLIGHT | 28BHB OPTION D**

Ext. Lgth: 33' 5" Ext. Ht: 135" Unloaded Wt (lbs.): 6,510 Sleeps: 9-10



**JAY FLIGHT | 28RLS OPTIONS: B, D**

Ext. Lgth: 32' 5" Ext. Ht: 134" Unloaded Wt (lbs.): 6,405 Sleeps: 3-6



**JAY FLIGHT | 29BHDS OPTION D**

Ext. Lgth: 34' 1" Ext. Ht: 135" Unloaded Wt (lbs.): 7,250 Sleeps: 8-10

**OPTIONS:**

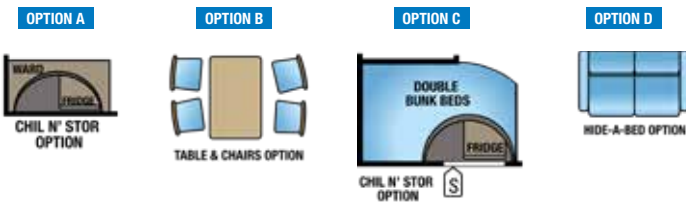

**FLOORPLAN LEGEND:**



**JAY FLIGHT | 29QBS | OPTION D**

Ext. Lgth: 34' 11" Ext. Ht: 134" Unloaded Wt (lbs.): 6,785 Sleeps: 8-10

**JAY FLIGHT | 29RKS | OPTIONS: B, D, E**

Ext. Lgth: 33' 9" Ext. Ht: 134" Unloaded Wt (lbs.): 6,700 Sleeps: 3-6

**JAY FLIGHT | 29RLDS | OPTIONS: D, E**

Ext. Lgth: 33' 2" Ext. Ht: 136" Unloaded Wt (lbs.): 6,735 Sleeps: 2-4

**JAY FLIGHT | 31QBDS | OPTION D**

Ext. Lgth: 35' 11" Ext. Ht: 135" Unloaded Wt (lbs.): 7,560 Sleeps: 8-10

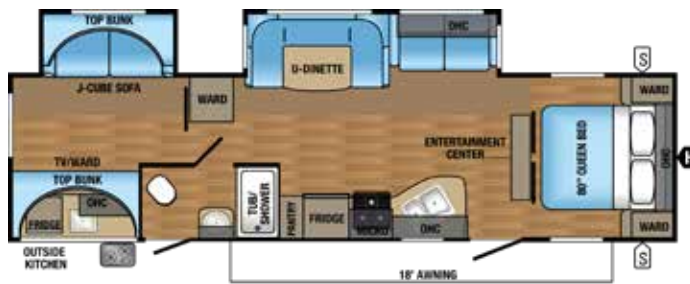
**JAY FLIGHT | 32BHDS | OPTION D**

Ext. Lgth: 36' 2" Ext. Ht: 135" Unloaded Wt (lbs.): 7,595 Sleeps: 8-10

**JAY FLIGHT | 32TSBH | OPTION D**

Ext. Lgth: 36' 2" Ext. Ht: 134" Unloaded Wt (lbs.): 8,240 Sleeps: 9-11

**JAY FLIGHT | 33RBTS | OPTIONS: B, D, F**

Ext. Lgth: 37' 8" Ext. Ht: 134" Unloaded Wt (lbs.): 8,530 Sleeps: 7-9

**JAY FLIGHT | 34RSBS | OPTIONS: B, E, G, H**

Ext. Lgth: 37' 6" Ext. Ht: 134" Unloaded Wt (lbs.): 8,600 Sleeps: 3-6



**JAY FLIGHT | 38BHDS** OPTIONS: D, H, I, J, K  
 Ext. Lgth: 40' 4" Ext. Ht: 135" Unloaded Wt (lbs.): 8,015 Sleeps: 8-10



**JAY FLIGHT | 38FDDS** OPTIONS: D, H, I  
 Ext. Lgth: 40' 4" Ext. Ht: 135" Unloaded Wt (lbs.): 7,990 Sleeps: 6-8

**OPTIONS:**

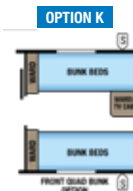
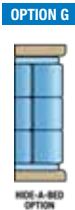
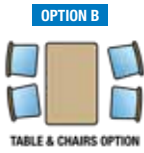

**FLOORPLAN LEGEND:**

- STORAGE
- TRAILER HITCH
- LAV BATHROOM SINK
- MEDICINE CABINET
- MICROWAVE
- OVERHEAD CABINETS
- FRIDGE REFRIGERATOR
- WARDROBE

**JAY FLIGHT SPECS**

MODELS	DIMENSIONS				WEIGHT (LBS.)				TANKS (GALS.)		
	FLOORPLAN	EXTERIOR TRAVEL LENGTH	EXTERIOR WIDTH	EXTERIOR HEIGHT (WITH A/C)	INTERIOR HEIGHT	UNLOADED VEHICLE WEIGHT	DRY HITCH WEIGHT	GROSS VEHICLE WEIGHT RATING	CARGO CARRYING CAPACITY	FRESH WATER CAPACITY (INCLUDES WATER HEATER)	GREY WASTE WATER CAPACITY
21QB	25' 6"	96"	127"	81"	4,385	490	6,500	2,115	90	39	39
23RB	27' 2"	96"	127"	81"	4,560	580	6,500	1,940	90	39	39
24RBS	28' 8"	96"	127"	81"	5,420	620	7,500	2,080	82	39	39
26BH	29' 3"	96"	127"	81"	4,805	525	7,000	2,195	90	39	39
27BHS	31' 8"	96"	130"	81"	6,335	605	8,250	1,915	82	39	39
28BHBE	33' 5"	96"	135"	81"	6,510	685	9,250	2,750	82	39	39
28RLS	32' 5"	96"	134"	81"	6,405	700	8,750	2,345	82	39	39
29BHDS	34' 1"	96"	135"	81"	7,250	695	9,750	2,500	86	71.5*	39
29QBS	34' 11"	96"	134"	81"	6,785	845	9,500	2,715	86	39	39
29RKS	33' 9"	96"	134"	81"	6,700	770	9,500	2,800	86	78*	39
29RLDS	33' 2"	96"	136"	81"	6,735	805	9,250	2,450	86	39	39
31QBDS	35' 11"	96"	135"	81"	7,560	860	10,250	2,690	86	40.5*	39
32BHDS	36' 2"	96"	135"	81"	7,595	955	9,975	2,380	86	32.5	39
32TSBH	36' 2"	96"	134"	81"	8,240	725	10,500	2,260	86	40.5*	39
33RBTS	37' 8"	96"	134"	81"	8,530	865	10,950	2,420	86	78*	32.5
34RSBS	37' 6"	96"	134"	81"	8,600	1,275	10,950	2,350	86	78*	39
38BHDS	40' 4"	96"	135"	81"	8,015	1,155	10,950	2,935	90	39	39
38FDDS	40' 4"	96"	135"	81"	7,990	1,145	10,950	2,960	90	39	39

\*Split Tank

**Unloaded Vehicle Weight (UVW):** Sometimes referred to as "Dry Weight," UVW means the typical weight of this trailer as built at the factory. The UVW, as used in product literature and other promotional materials, does not include cargo, fresh water, propane, options or dealer-installed accessories.

**Gross Vehicle Weight Rating (GVWR):** GVWR means the maximum permissible weight of the trailer, including the UVW plus passengers, personal items, all cargo, fluids, options and dealer-installed accessories. The GVWR is equal to or greater than the sum of the UVW and the CCC.

**Cargo Carrying Capacity (CCC):** CCC means the maximum weight of all passengers, personal items, food, fresh water, propane, tools, other cargo and dealer-installed accessories that can be carried by the trailer. CCC is equal to or less than GVWR minus UVW. The addition of options will decrease the CCC.

**Hitch Weight (HW):** The hitch weight, as used in product literature and other promotional materials, does not include cargo, fresh water, propane gas, options or dealer-installed accessories. The addition of these types of items will either add to or subtract from the stated hitch weight.

It is important for your safety and enjoyment that your tow vehicle be adequately sized and equipped to tow and handle the GVWR of the RV you select. Review weights and rating of your tow vehicle and consult a competent advisor for questions or advice. Whether you are new to RVing or a veteran, get a feel for the performance of your tow vehicle before heading out on the roadways. When you tow an RV, you must drive differently than when you drive a single vehicle. Practice hooking up, driving, backing up and braking in a safe environment or seek out professional instruction. Jayco affixes a weight label to each RV which lists weight information for that vehicle. See specifications chart above.

	Jay Flight SLX (7-foot)	Jay Flight SLX (8-foot)	Jay Flight
<b>Exterior Equipment</b>			
I-class cambered structural steel I-beams		S	S
3-inch, cambered, steel box tube frame	S		
Fully integrated A-frame	S	S	S
Front diamond plate	CVP	CVP	S
Power tongue jack			CVP
20-pound propane bottle(s)	S (1)	S (2)	
30-pound propane bottles with cover (2)			CVP
5/8-inch tongue-and-groove plywood floor decking		S	S
Magnum Truss™ Roof System with seamless DiFlex II material	S	S	S
2-sided, reflective foil insulation in flush-floor slideout room floors		S	S
Large exterior downspouts			S
30-inch x 72-inch main entrance door			S
Large entry door grab handle			ELITE
Amber patio light	S	S	
Entrance doors and baggage doors all Keyed-Alike™	S	S	S
Radial tires with galvanized steel, impact-resistant wheel wells	S	S	S
Front window with integrated rock guard	S		
Spare tire with cover	S	S	CVP
Solar prep			ELITE
Sani-Con® holding tank emptying system		0	0
Black tank flush			ELITE
Second fresh water tank (80-gallon capacity)		BAJA OPTION	ELITE
Exterior speakers	S	S	S
Power awning	CVP	CVP	
Power awning with LED light			S
Pullout camp kitchen (24RBS, 27BHS, 242BHSW, 284BHSW)		S	S
Outside kitchen (std. in 29BHDS, 32BHDS, 32TSBH and 33RBT; opt. in 29QBS and 31QBDS)			S/O
Outside shower		S	CVP
Utility lighting system			S
Aluminum rims			0
13,500-BTU roof-mounted A/C	0	S	CVP
15,000-BTU roof-mounted A/C		0	0 - CVP
Wall-mounted 8,000-BTU A/C	S		
30-amp service	S	S	S
50-amp service with second A/C prep (select models) (std. in 34RSBS)		0	0
Second A/C in bedroom (select models)			0
Electric stabilizer jacks (4)			0

	Jay Flight SLX (7-foot)	Jay Flight SLX (8-foot)	Jay Flight
Cargo accessory receiver (n/a on 21QB, 23RB, 26BH, 27BHS)			0
Chil N' Stor (23RB, 26BH, 245RLSW)		0	0
Bumper-mount outside grill			0
Patio door (29RKS, 29RLDS, 34RSBS) (std. on 38BHDS, 38FDDS)			0
Enclosed underbelly		0	
Thermal Package: Insulated, heated (n/a on 23RB, 26BH) and enclosed underbelly and 2-sided reflective foil insulation in main roof and slideout floors			0
Fiberglass sidewalls with frameless windows			0
Roof ladder			0
Stabilizer jacks with sand pads	CVP (2)	CVP (4)	S (4)
<b>Baja Edition Package (Idaho build units only):</b> Triple step, stabilizer jacks (4), black diamond plate sidewall skirt, 30-pound propane bottle, off-road tires with black rims, flipped axle, enclosed underbelly, 20-gallon fresh water tank (145RB, 154BH), 30-gallon fresh water tank (174BH, 175RD, 195RB), double-tread step	0		
<b>Baja Edition Package (Idaho build units only):</b> Solar prep, triple step, 16-inch off-road tires, flipped axle, enclosed underbelly, second fresh water tank (80-gallon capacity), double-tread step		0	

### Interior Equipment

81-inch ceiling height		S	S
Maple mission-style cabinet doors	S	S	ELITE
Wardrobe/pantry storage	S	S	S
Coat hook by entry door (select models)			S
Acrylic sink	S		
Large 60/40 kitchen sink		S	
Large 60/40 kitchen sink with pullout faucet			ELITE
Kitchen sink covers			ELITE
2-burner range	S		
3-burner range with 9,000-BTU SuperBurner™ and piezo igniter		S	S
Range hood	CVP	CVP	S
Oven		S	
Stainless oven			ELITE
Vented kitchen window			S
Kitchen skylight with shade			0
LED accent lighting in kitchen			S
3-cubic-foot refrigerator with temperature controls	S		
6-cubic-foot Norcold® refrigerator with temperature controls		S	

## JAY FLIGHT SLX INTERIOR DÉCOR (8-FOOT-WIDE MODELS ONLY)

### EARTH



### SMOKE



Jay Flight SLX (7-foot)  
 Jay Flight SLX (8-foot)  
 Jay Flight

Interior Equipment (Continued)			
8-cubic-foot refrigerator with stainless front (18-cubic-foot residential refrigerator in 38BHDS, 38FDDS)			ELITE
Microwave	S	S	
Stainless microwave			ELITE
Brushed nickel faucets	S	S	S
6-gallon gas water heater	CVP		
6-gallon gas DSI water heater		CVP	
6-gallon gas/electric DSI water heater (10-gallon in 38BHDS, 38FDDS)			CVP
Water heater bypass	CVP	CVP	CVP
Decorative dinette and slideout room lighting (SuperSlide models)			S
Vented windows in the slideout room end walls (SuperSlide models)			S
Smoked-glass cabinet inserts (select models)		S	S
Indoor/outdoor dinette table (select models)	S		
Up/down-style dinette table (main booth dinette only)			S
Freestanding table with 4 chairs (select models) (std. on 29RLDS)			0
Hidden-switch command/charging center			S
Backup/security camera prep			S
Dual USB/12V charging port			ELITE
Premium multimedia sound system with MP3/iPod® input jacks and Bluetooth® connectivity	S	S	
AM/FM/CD/DVD player with MP3 input and Bluetooth and HDMI® connectivity			ELITE
J-Steel™ jackknife sofa		S	S
DiamondFlor® vinyl flooring	S	S	S
Shaw® residential-grade carpet		S	S
Pleated window shades	CVP	CVP	S
Digital TV antenna	S	S	CVP
Cable/satellite TV hookup		S	CVP
Glass shower door (select models)			S
Marine toilet with foot flush	S	S	
Porcelain foot flush toilet			ELITE
Shower curtain with curved shower track (select models)	S	S	S
Tub surround		S	CVP
Bathroom skylight	CVP	CVP	CVP
Bathroom power fan			CVP
Wood-trimmed mirror in bathroom	S	S	
Residential-height plywood bed platforms	S	S	S

Jay Flight SLX (7-foot)  
 Jay Flight SLX (8-foot)  
 Jay Flight

Main bed struts			S
Queen Simmons® mattress (n/a on some 7-foot models)	S	S	S
300-pound-rated bunk beds (select models)	S	S	S
600-pound-rated bunk beds (double bunks)		S	S
Privacy curtains in bunk areas (select models)		S	S
Vented bunk windows (select models)			S
4-inch-thick bunk mats (select models)	S	S	S
Wooden bedroom doors (select models)			S
Rear sofa with folding bunk (33RBTS)			0
King bed (34RSBS, 38BHDS, 38FDDS)			0
Front quad bunk (38BHDS)			0
Front queen bed (38BHDS)			0
Hide-a-bed (select models)			0
Sofa with folding bunk (33RBTS)			S
Bedsread with shams		0	S
Queen bedsread (174BH, 185RB, 195RB and all 8-foot models)	0	0	
29-inch LED TV (model specific)			0
32-inch LED TV (model specific)			0
39-inch LED TV (model specific) (std. on 34RSBS, 38BHDS, 38FDDS)			0
48-inch LED TV (284BHSW)		S	
Fireplace (29RLDS, 33RBTS, 38BHDS)			0
Linoleum in living area (33RLDS, 34RSBS, 38FDDS)			0
Multifunctional digital remote			0

S - Standard      CVP - Customer Value Package (mandatory option)  
 0 - Optional      ELITE - Elite Package (mandatory option)

### ELITE PACKAGE:

- Black tank flush
- Second fresh water tank (80-gallon capacity)
- Large main entry door grab handle
- Upgraded faucet with pullout sprayer
- Sink covers
- Porcelain foot flush toilet
- Stainless microwave
- Stainless oven
- Stainless refrigerator front
- Hardwood frame mission-style maple cabinet doors
- AM/FM/CD/DVD player with MP3 hookup/Bluetooth/HDMI
- Solar prep
- Dual USB and 12V charging port

## JAY FLIGHT INTERIOR DÉCOR

### SHADOW



### TUMBLEWEED



### MINERAL



### CANYON





40RLTS | PEPPERCORN

### POPULAR OPTIONS



POWER AWNING WITH LED LIGHT



FIBERGLASS SIDEWALLS



THEATER SEATING



THEATER SEATING RECLINED

## MAIN INTERIOR KEY

1. Wood-look blinds
2. Residential refrigerator (shown with optional stainless)
3. Free-standing range (shown with optional stainless)
4. Large panoramic windows
5. 39-inch TV
6. Fireplace with ledgestone
7. Wood-look vinyl flooring
8. Interior LED lighting
9. Raised-panel hardwood doors with mortise-and-tenon joints
10. 30-inch residential microwave (shown with optional stainless)



# JAY FLIGHT BUNGALOW

## STANDARD FEATURES

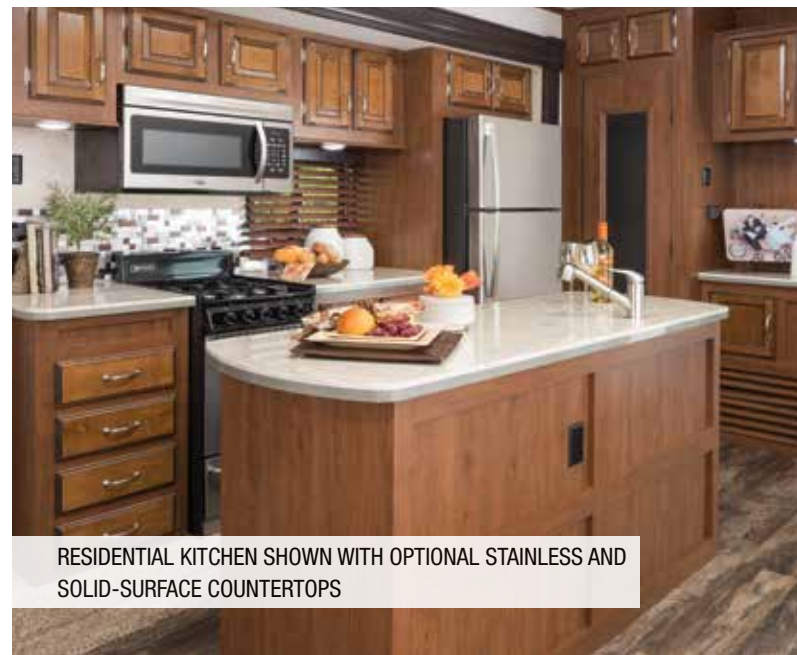

RESIDENTIAL KITCHEN SHOWN WITH OPTIONAL STAINLESS AND SOLID-SURFACE COUNTERTOPS



SELF-RETRACTING CENTRAL VACUUM SYSTEM



WASHER/DRYER PREP (SELECT MODELS)



**JAY FLIGHT BUNGALOW | 40BHQS** OPTIONS: A, B, C, D  
Ext. Lgth: 40' 2" Ext. Ht: 151" Unloaded Wt (lbs.): 11,220 Sleeps: 6-10



**JAY FLIGHT BUNGALOW | 40BHTS** OPTIONS: C, D  
Ext. Lgth: 40' 11" Ext. Ht: 151" Unloaded Wt (lbs.): 10,570 Sleeps: 5-7



**JAY FLIGHT BUNGALOW | 40FKDS** OPTIONS: C, D  
Ext. Lgth: 40' 11" Ext. Ht: 152" Unloaded Wt (lbs.): 10,425 Sleeps: 2-4



**JAY FLIGHT BUNGALOW | 40FSDS** OPTIONS: C, D  
Ext. Lgth: 41' 8" Ext. Ht: 152" Unloaded Wt (lbs.): 10,030 Sleeps: 4



**JAY FLIGHT BUNGALOW | 40LOFT** OPTIONS: C, D  
Ext. Lgth: 40' 10" Ext. Ht: 151" Unloaded Wt (lbs.): TBD Sleeps: 6



**JAY FLIGHT BUNGALOW | 40RLTS** OPTIONS: C, D  
Ext. Lgth: 40' 2" Ext. Ht: 151" Unloaded Wt (lbs.): 10,805 Sleeps: 4

**OPTIONS:**



**FLOORPLAN LEGEND:**

- STORAGE
- TRAILER HITCH
- LAV BATHROOM SINK
- MED MEDICINE CABINET
- MICRO MICROWAVE
- OHC OVERHEAD CABINETS
- FRIDGE REFRIGERATOR
- WARD WARDROBE

**JAY FLIGHT BUNGALOW SPECS**

MODELS	DIMENSIONS				WEIGHT (LBS.)				TANKS (GALS.)		
	FLOORPLAN	EXTERIOR TRAVEL LENGTH	EXTERIOR WIDTH	EXTERIOR HEIGHT (WITH A/C)	INTERIOR HEIGHT	UNLOADED VEHICLE WEIGHT	DRY HITCH WEIGHT	GROSS VEHICLE WEIGHT RATING	CARGO CARRYING CAPACITY	FRESH WATER CAPACITY (INCLUDES WATER HEATER)	GREY WASTE WATER CAPACITY
40BHQS	40' 2"	102"	151"	96"	11,220	1,460	13,000	1,780	48	78*	78
40BHTS	40' 11"	102"	151"	96"	10,570	1,650	13,000	2,430	48	78*	39
40FKDS	40' 11"	102"	152"	96"	10,425	1,575	13,000	2,575	48	78*	39
40FSDS	41' 8"	102"	152"	96"	10,030	1,545	12,500	2,470	48	39	39
40LOFT	40' 10"	102"	151"	96"	TBD	TBD	TBD	TBD	48	71.5*	39
40RLTS	40' 2"	102"	151"	96"	10,805	1,480	13,000	2,195	48	32.5	39

\*Split Tank

Use Jay Flight Bungalow only for its intended purpose of seasonal use on a semi-permanent site.



# JAY FLIGHT BUNGALOW STANDARDS AND OPTIONS

## CUSTOMER VALUE PACKAGE (mandatory)

- 15,000-BTU central A/C
- 30-pound propane bottles with cover
- Bath skylight
- Premium sound system with CD/DVD player, MP3 input and Bluetooth® and HDMI® connectivity
- Manual stabilizer jacks
- 30-inch microwave
- Power vent in bathroom
- Quilted bedspread with shams
- Sink covers (2)
- Tub surround
- Water heater bypass

## STANDARD EXTERIOR EQUIPMENT

- 102-inch wide-body construction
- Magnum Truss™ Roof System with seamless DiFlex II material
- 5/8-inch tongue-and-groove plywood floor decking
- 12-inch, I-class cambered structural steel I-beams
- 2-sided reflective foil in flush-floor slideout room floors
- Electric-powered slideout rooms with enclosed gear system
- Radial tires with galvanized steel, impact-resistant wheel wells
- E-Z Lube® axles
- 60-inch, residential-style sliding patio door with Low-E thermal-pane glass
- Exterior marine-grade speakers (2)
- Manual patio awning
- G20 dark-tinted windows
- Atrium-style front wall with integrated lights
- Utility lighting system
- Detachable hitch
- Outside shower
- Black tank flush sprayer
- Solar prep

## STANDARD INTERIOR EQUIPMENT

- 96-inch interior height
- 84-inch-tall interior doorways
- 82-inch slideout room interior height
- 120V ceiling fan in living room and bedroom
- Raised-panel cabinet doors with mortise-and-tenon corners
- Ball-bearing drawer guides, 75-pound capacity, full extension
- 18-cubic-foot, residential-style, 120V refrigerator with ice maker
- 20-inch free-standing 4-burner gas range with oven
- Large 60/40, deep-bowl acrylic kitchen sink with residential pullout sprayer
- 16-gallon effective (10-gallon tank) gas/electric DSI water heater
- Auto-ignition furnace
- Hardwood-look vinyl flooring
- Residential Shaw® carpet with padding
- Wood-look blinds in living room
- Residential-style window treatments
- Night shades in bedroom
- Hide-a-bed with tri-fold mattress
- Electric fireplace with thermostat controls and ledgestone surround
- Cable/satellite prep
- Hidden-switch command/charging center
- Dual USB/12V charging port in bedroom
- Medicine cabinet with mirror
- Porcelain toilet with foot flush
- Simmons® pillow-top mattress
- Residential-height master bed
- Bedroom stereo speakers (2)
- Plywood bed, dinette and bunk bases with 300-pound-rated bunks and Simmons mattress mats
- Central vacuum with push-button retract for easy hose storage
- Electrical outlets in master bedroom on each side of the bed
- Vented end windows in living room and bedroom slideout rooms (select models)
- 6-panel-style bathroom and master bedroom doors
- Interior LED lighting
- Recessed LED lights in kitchen area

- Living room throw pillows
- Upgraded reading lights in master bedroom
- Upgraded living room furniture style with all new décor
- Decorative dinette ceiling light
- Smoked-glass insert on select cabinets
- Crown molding on kitchen overhead cabinets
- Deluxe bar stools (select models)
- Backup/security camera prep
- Living room crown molding
- Kitchen power vent with wall control
- Bathroom power vent with wall control

## OPTIONS

- Thermal Package: Insulated, heated and enclosed underbelly and 2-sided, reflective foil insulation in main roof and slideout room floors
- Desk chair (40BHQS)
- Dinette in off-doorside bunk slideout room (40BHQS)
- Electric patio awning with LED light
- Fiberglass sidewalls
- Jackknife sofa in doorside slideout room (40BHQS)
- King bed
- Roof ladder
- Second A/C in bedroom (13,500-BTU)
- Slideout awnings
- Solid-surface kitchen countertops
- Stainless steel kitchen appliances
- Theater seats in main living area slideout room
- Thermal-pane, tinted safety-glass windows

# JAY FLIGHT BUNGALOW INTERIOR DÉCOR

### JAVA

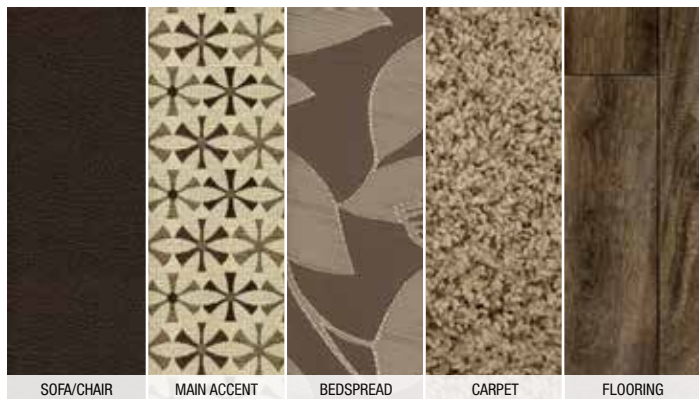

### PEPPERCORN



### MEADOW

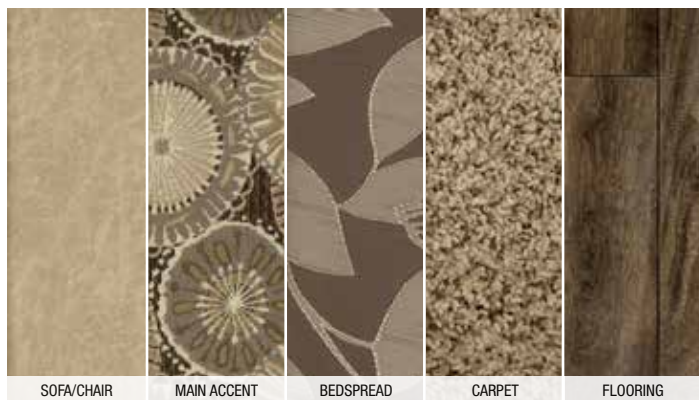

### CASHMERE



# MAKING MEMORIES

## THAT LAST GENERATIONS—LET'S JAYCO

Whether you're out for excitement, relaxation or just time together, we take steps others don't to help you stay focused on the fun. No cutting corners here. Let us go the extra mile so you don't have to.



### THE JAYCO DIFFERENCE

1. **Hand-tucked and glued fiberglass insulation** increases the insulation value near the 2-inch x 2-inch wooden studs; competitors use a blanket-insulation technique
2. **An optional fiberglass package** offers a smooth, sleek look; front walls are vacuum-bonded for added durability, while the sidewalls and rear walls are pinch rolled, for an affordable combination
3. **Magnum Truss™ Roof System** withstands 4,500 pounds—50 percent more than other roofs; by using  $\frac{3}{8}$ -inch plywood decking (n/a on Jay Flight SLX) screwed down at every seam, we offer higher durability than competitors' stapled construction; a one-piece, sidewall-wrapped DiFlex II material provides the ultimate in leak protection
4. **Durable floors** feature  $\frac{5}{8}$ -inch tongue-and-groove plywood (n/a on Jay Flight SLX) on 2-inch x 3-inch wooden joists, wrapped with a protective moisture barrier to keep the elements at bay
5. **Galvanized steel wheel wells**, not found on competing models, reduce heat loss and prevent damage in case of road debris
6. **Integrated A-frame** prevents the hitch from buckling



### JAY FLIGHT BUNGALOW EXCLUSIVE

7. **A unique residential-style atrium profile** creates a more home-like feel; vented windows and a 60-inch patio door maximize your comfort
8. **A detachable hitch** lets you remove the hitch during long-term stays

WE START WITH ONE OF THE INDUSTRY'S  
**strongest**  
**foundations**

Many competitors modify or weld stock frames, which can weaken the integrity of your foundation. Jayco's custom-manufactured frames offer higher strength and durability.

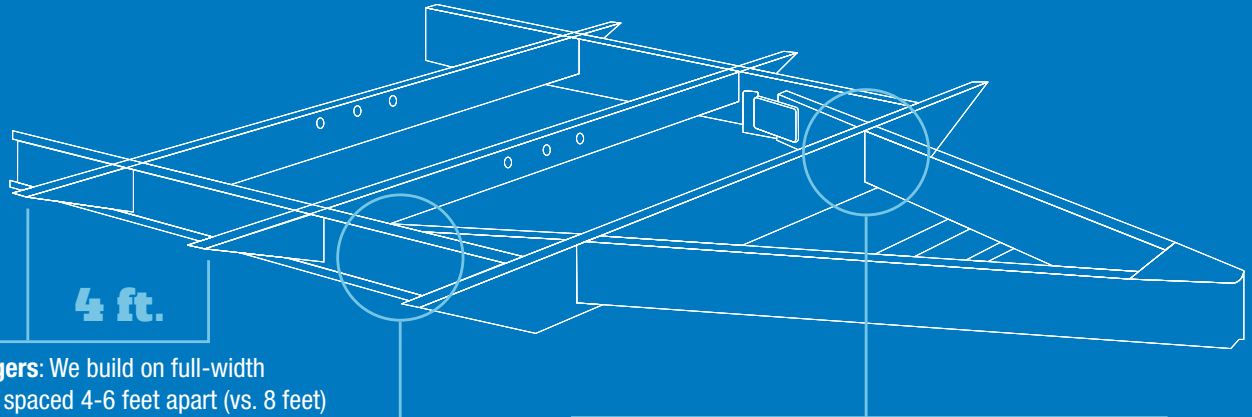

4 ft.

**Full-width outriggers:** We build on full-width outriggers that are spaced 4-6 feet apart (vs. 8 feet) to better support the weight of the wall.

**I-class cambered structural steel I-beams:** Jayco uses a unique molded, one-piece design to prevent the unit from twisting; competing three-piece I-beams can warp over time at the welded seams.

**Integrated A-frame:** The A-frame runs through the main frame, preventing the hitch from buckling—a common issue in competing tack-welded designs; seasonal travel trailers have a detachable hitch in lieu of an integrated A-frame.

Learn more at [StrongFoundation.Jayco.com](http://StrongFoundation.Jayco.com)

## JAYCO'S ROOF **VS** OTHER ROOFS



4,500 POUNDS ON A JAYCO ROOF VS. OTHER ROOFS

THE MAGNUM TRUSS™ ROOF SYSTEM  
**50 percent stronger**



## TRAVEL WITH CONFIDENCE

At Jayco, we build our RVs to handle every adventure, then back them with our industry-leading 2-year limited warranty. We, with support from our select partners, have you covered for **2 camping seasons**. That's **730 days**. You won't find a better warranty in the business, because the only strings we attach are those that deliver the ultimate in reliability. That's the Jayco difference. So go explore. We have the warranty that will follow you anywhere. For a copy of our 2-year limited warranty with full terms and conditions, please contact your local Jayco dealer.



## JAYCO'S INDUSTRY-LEADING 2-YEAR LIMITED WARRANTY



**FREE**

A year's access to Coach-Net™—the country's largest RV emergency road service.

ROADSIDE ASSISTANCE



### Meet your Jayco Dealer

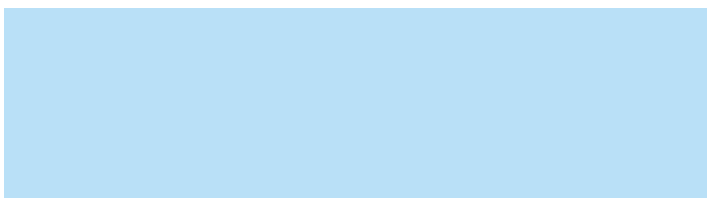

We work hard—so you can play hard. From finding the perfect Jayco for your family to providing flexible financing options and full-service support, we're here to help.

## eco advantage™

**Jayco's long-term commitment to generations of family fun**

After five years of increased efforts to eliminate waste, conserve energy and increase recycling, we've come a long way in building RVs that are not only better for your family—but also better for the planet.

**Learn more at [Jayco.com/EcoAdvantage](http://Jayco.com/EcoAdvantage)**

### Follow Jayco



**Jayco, Inc., PO. Box 460, Middlebury, IN 46540, [www.jayco.com](http://www.jayco.com)** See dealer for further information and prices. All information in this brochure is the latest available at the time of publication approval. Jayco reserves the right to make changes and to discontinue models without notice or obligation. Photos in this brochure may show optional equipment and props for photography purposes. RVs built for sale in Canada may differ to conform to Canadian codes. ©2016 Jayco, Inc. 274737 1016-18.6K Printed in U.S.A.